

COUPLING CONSTANTS AND STRUCTURE: VICINAL COUPLINGS

- Vicinal ^1H - ^1H coupling constants ($^3J_{\text{HH}}$) are particularly useful for molecular structure studies
- In the late 1950's and early 1960's, Martin Karplus established a relationship between the dihedral (torsion) angle between vicinal hydrogens and the $^3J_{\text{HH}}$ coupling constant using a largely theoretical (valence-bond) approach
- This important relationship is now called the “Karplus relationship”

Karplus, Martin (1959). "Contact Electron-Spin Coupling of Nuclear Magnetic Moments". *J Chem. Phys.* 30 (1), 11-15

*Karplus, Martin (1963). "Vicinal Proton Coupling in Nuclear Magnetic Resonance". *J. Am. Chem. Soc.* 85 (18), 2870-2871.

* This is the 17th most cited article in JACS history

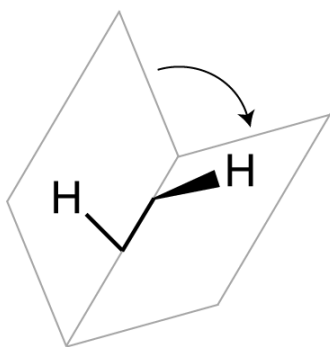

dihedral/torsion angle is the angle between the two C-C-H planes

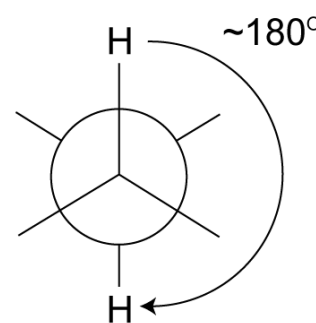

$^3J_{\text{HH}}$ large (~ 15 Hz)

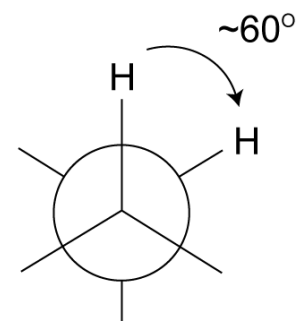

$^3J_{\text{HH}}$ small (~ 5 Hz)

“The dependence of the vicinal coupling constant on the dihedral angle, as formulated by Karplus, is without doubt one of the most important relationships in conformational analysis, possibly more so than any other.” - *Horst Freibolin*, from “*Basic One-and Two-Dimensional NMR Spectroscopy*”, Fourth Edition, 2005.

COUPLING CONSTANTS AND STRUCTURE: VICINAL COUPLINGS

- The general form of the Karplus relationship is:

$${}^3J(\phi) = A \cos^2(\phi) + B \cos(\phi) + C$$

where the coefficients (A, B, and C) are parameterized for particular molecule types, atoms and substituents.

“Karplus curve” for ethane derivatives,

$${}^3J_{HH}(\phi) = 12 \cos^2(\phi) - \cos(\phi) + 2$$

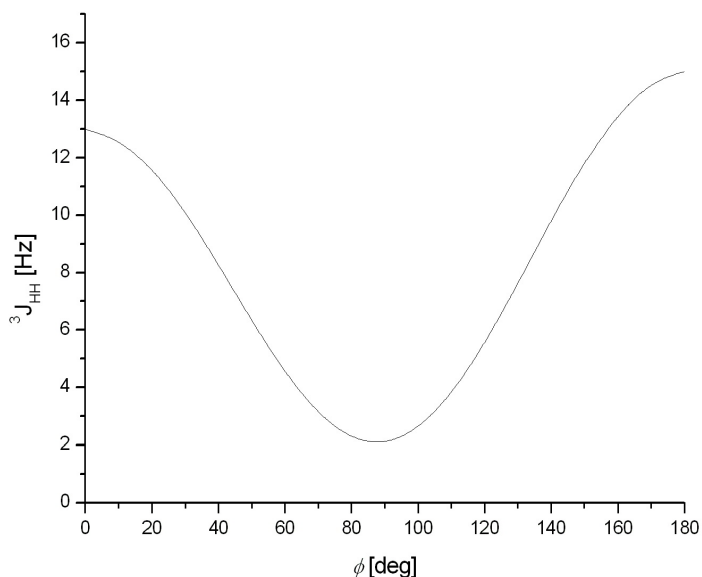

Minch, M. J. (1994). "Orientational Dependence of Vicinal Proton-Proton NMR Coupling Constants: The Karplus Relationship". *Concepts in Magnetic Resonance* **6**, 41-46.

Karplus curve parameterized for defining the main chain angle ϕ ($\text{CO}_{i-1}-\text{N}_i-\text{C}\alpha_i-\text{CO}_i$) in protein molecules (${}^3J(\phi) = 7.0 \cos^2(\phi) - 1.4 \cos(\phi) + 1.7$)

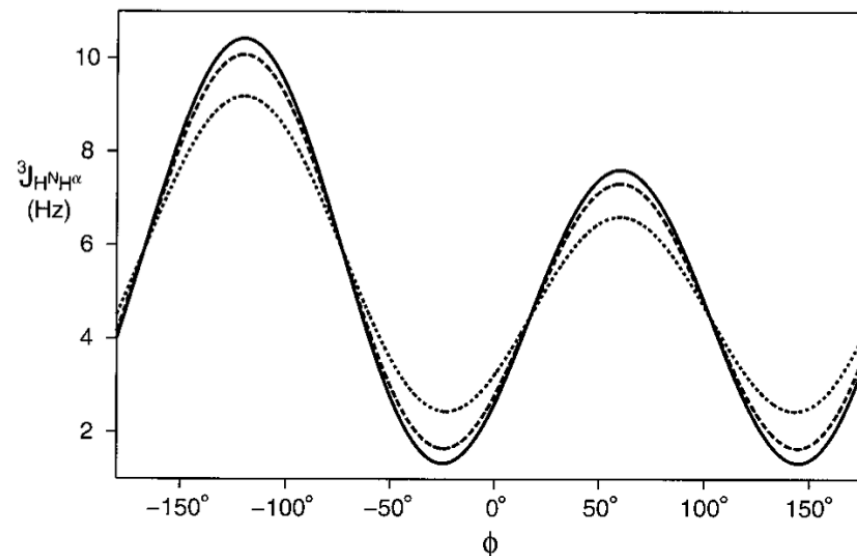

Wang, A. C., and Bax, A. (1996) Determination of the Backbone Dihedral Angles in Human Ubiquitin from Reparametrized Empirical Karplus Equations. *J. Am. Chem. Soc.* **118**, 2483-2494.

COUPLING CONSTANTS AND STRUCTURE: VICINAL COUPLINGS

- The dihedral angle dependence of the magnitude of vicinal couplings results from molecular orbital overlap
 - the σ C-C bond and the σ C-H bonds are nearly perpendicular, so there is little overlap
 - overlap of the sp^3 hybrid orbitals governs the magnitude of the coupling
 - maximum orbital overlap occurs when the dihedral angle is 0° and 180° ($^3J_{HH}$ is large)
 - the orbital overlap is minimal when the dihedral angle is 90° ($^3J_{HH}$ is small)

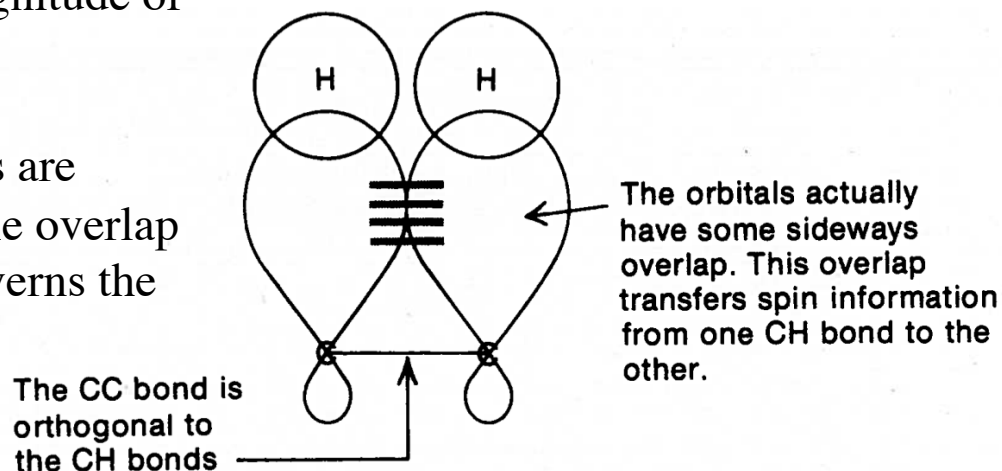

$\alpha = 0^\circ$ (side view)

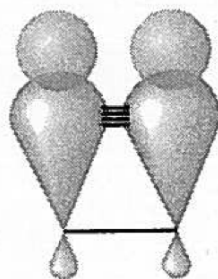

MAXIMUM OVERLAP

$\alpha = 90^\circ$ (end view)

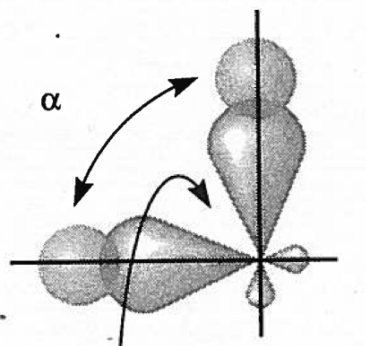

Little or no overlap when orbitals are perpendicular

MINIMUM OVERLAP

$\alpha = 180^\circ$ (side view)

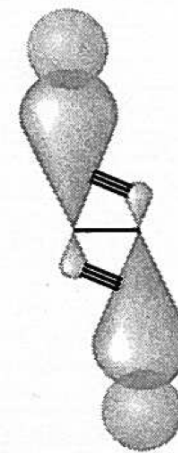

MAXIMUM OVERLAP

VICINAL COUPLINGS AND KARPLUS RELATIONSHIPS:

EXAMPLES

Ethane derivatives, rotameric states, and rotameric averaging

- In ethane derivatives (ethyl groups), the dihedral angle for *gauche* rotamers 1 and 3 is about 60° , whereas for the *trans* rotamer the dihedral angle is 180°

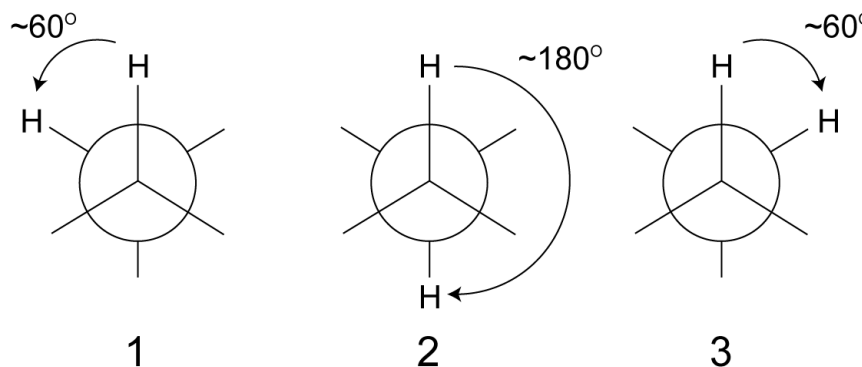

- Therefore, according to the Karplus curve:
 - the ^1H - ^1H coupling constant is about 4 Hz for rotamers 1 and 3 ($^3J_1 = ^3J_3 \approx 4 \text{ Hz}$)
 - the ^1H - ^1H coupling constant is about 13 Hz for rotamer 2 ($^3J_2 \approx 13 \text{ Hz}$)
- The fraction of the total compound that adopts each of the three rotameric conformations will depend on the substituents
 - these fractions will be represented as F_1 , F_2 , and F_3 ($F_1 + F_2 + F_3 = 1$)
- The *observed* coupling constant (assuming fast rotation about the C-C bond) is given by:

$$^3J_{\text{observed}} = F_1 ^3J_1 + F_2 ^3J_2 + F_3 ^3J_3$$

VICINAL COUPLINGS AND KARPLUS RELATIONSHIPS:

For ethane derivatives (assuming free rotation about the C-C bond):

EXAMPLES

$${}^3J_{\text{observed}} = F_1 {}^3J_1 + F_2 {}^3J_2 + F_3 {}^3J_3$$

- Example 1: rotamers 1, 2, and 3 are isoenergetic
 - in this case, the equilibrium populations of each are identical ($F_1 = F_2 = F_3 = 1/3$)
 - the observed coupling constant is then just the average of 3J_1 , 3J_2 and 3J_3 :

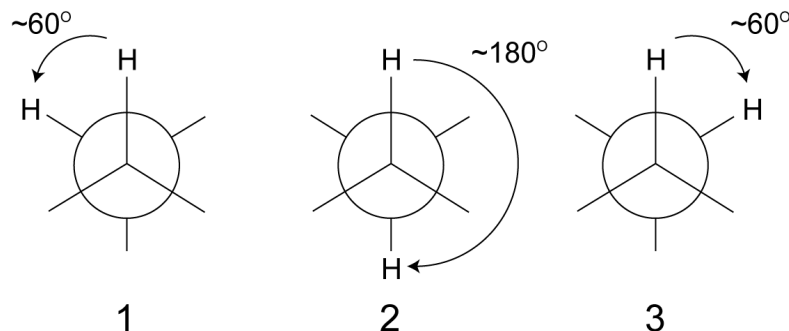

$${}^3J_{\text{observed}} = F_1 {}^3J_1 + F_2 {}^3J_2 + F_3 {}^3J_3 \approx 1/3 \times 4 + 1/3 \times 4 + 1/3 \times 13 \approx 1/3 \times 21 \approx 7$$

- Example 2:

- the observed value of ${}^3J_{\text{HH}}$ for either isomer (*erythro* or *threo*) of 2-methyl-3-dimethylamino-3-phenylpropionic acid ethyl ester is 11 Hz (pretty large)

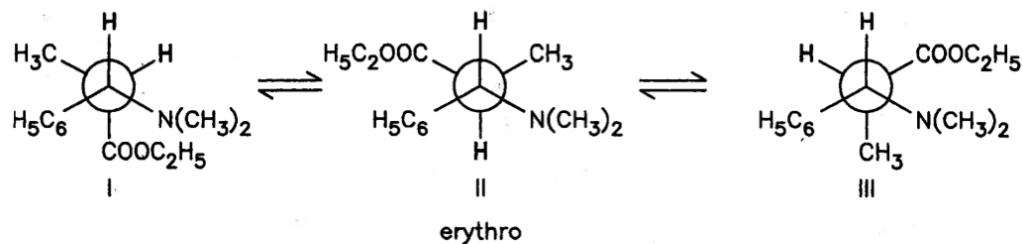

- thus, conformer II is the lowest energy conformer, and is present at higher concentrations than I or III at equilibrium (${}^3J_{\text{II}} \approx 13$ Hz, ${}^3J_{\text{I}} = {}^3J_{\text{III}} \approx 4$ Hz)

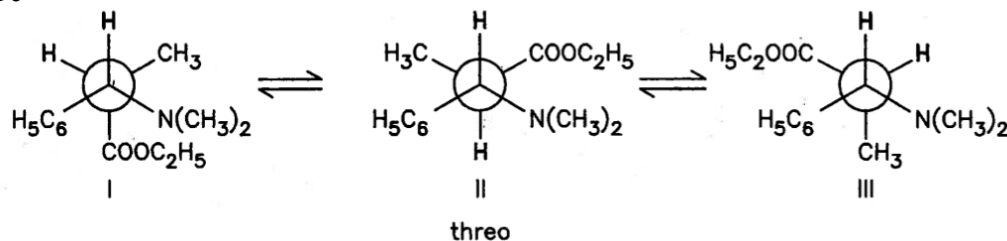

VICINAL COUPLINGS AND KARPLUS RELATIONSHIPS:

EXAMPLE 3: cyclohexane derivatives

- in the cyclohexane derivatives shown, chair-chair interconversion is prevented by the *tert*-butyl group in the equatorial position
- the values for the vicinal coupling constants are dependent on the dihedral angle in a fashion consistent with the Karplus relationship

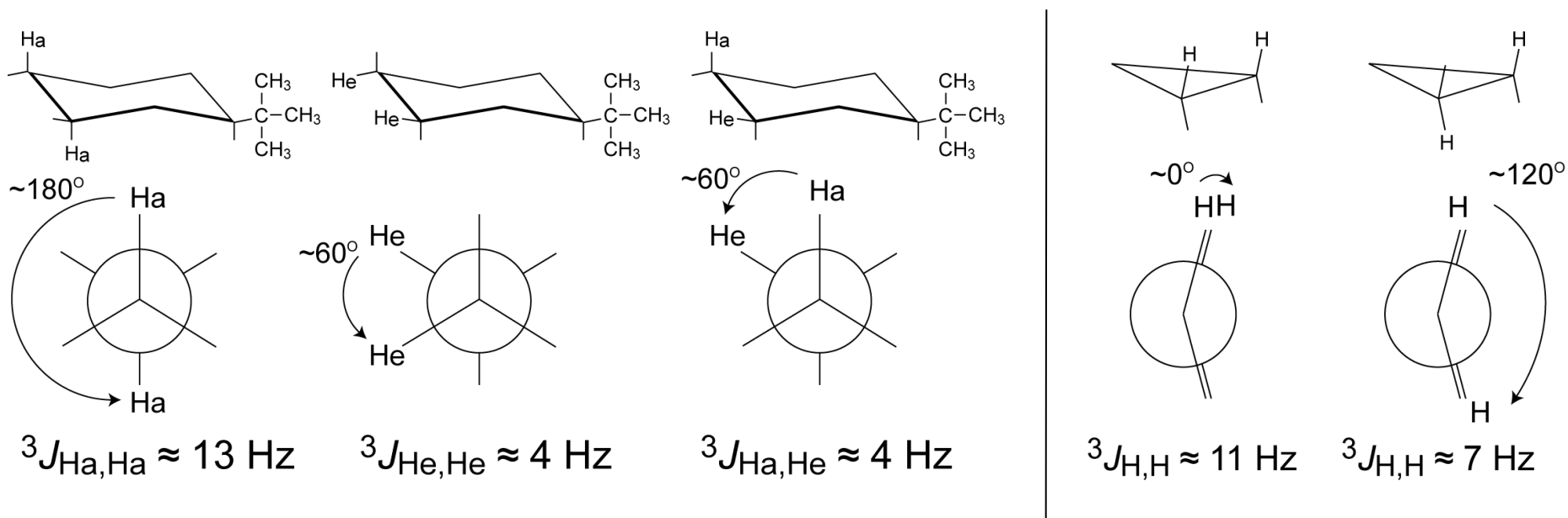

• Example 4: cyclopropane derivatives

- note that in the “trans” arrangement, the bond angle is only about 120°, and in accord with the Karplus curve, the coupling constant is smaller than for the “cis”

VICINAL COUPLINGS IN ALKENES

- The vicinal coupling constants across the double bond in alkenes are reasonably distinct
- The *cis* and *trans* couplings are both affected appreciably by electronegativities of substituents (coupling decreases with increasing electronegativity)
- The magnitudes of the couplings (${}^3J_{\text{HH}}$) are useful for distinguishing between *cis* and *trans*
- The essentially parallel C-H bonds in the *trans* conformer improve orbital overlap (as opposed to the *cis* case where the bonds are tilted away from one another)

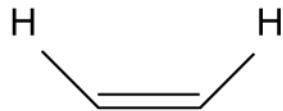

$${}^3J_{\text{H,H}} \approx 6 \text{ to } 15 \text{ Hz}$$

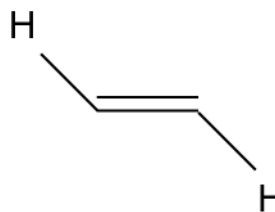

$${}^3J_{\text{H,H}} \approx 11 \text{ to } 18 \text{ Hz}$$

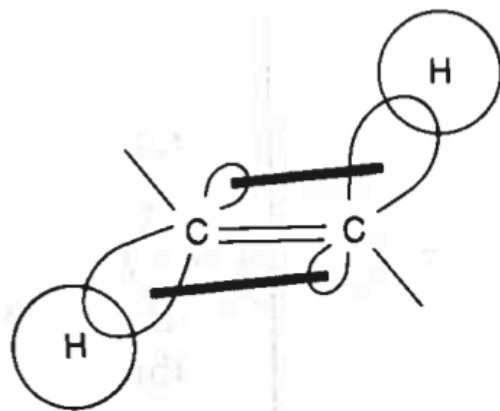

TRANS

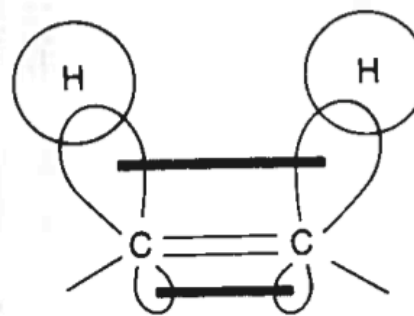

CIS

“LONG-RANGE” COUPLINGS

- Couplings between atoms 4 or more bonds away from one another (${}^XJ_{\text{HH}}$, $X>3$) collectively are denoted “long-range” couplings
- These tend to be small and not generally observable
- However, in some systems, they are observable (~ 0.5 Hz) and can be quite large (≥ 7 Hz)
- They are possible, in those systems where they are observed, due to a fortuitous arrangement of overlapping orbitals

“LONG-RANGE” COUPLINGS: SATURATED SYSTEMS

- Observable (~ 0.5 Hz or larger) “long-range” couplings ($^X J_{\text{HH}}$, $X > 3$) in saturated compounds (no π systems) are not common
- However, in some cases, when the atoms form a “W”, four-bond ($^4 J_{\text{HH}}$) couplings (**H-C-C-H**) are large enough to be observed
- It is not understood precisely the mechanism of orbital overlap that accounts for these couplings
- The magnitudes of these range from very small (0.5 Hz, or just observable) to rather large (7 Hz or larger)
- In strained rigid systems, the size of the observed couplings becomes larger as the apparent strain in the system increases

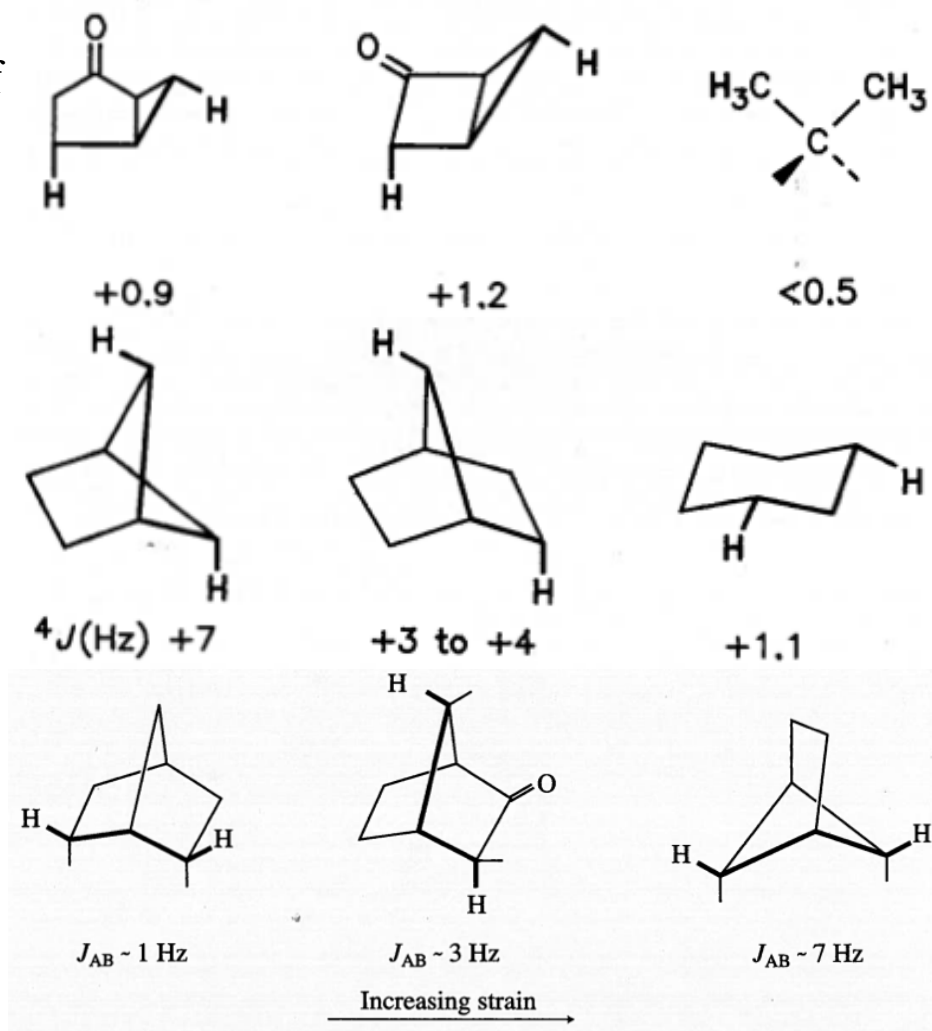

“LONG-RANGE” COUPLINGS: ALLYLIC COUPLINGS IN ALKENES

- Observable four-bond (${}^4J_{\text{HH}}$) couplings between hydrogens on carbon atoms α to the double bond and hydrogens at the opposite end of the double bond called allylic couplings
- Apparently, orbital overlap between the π orbital of the double bond and the hybrid sp^3 -C-H orbital enable the nuclear interactions that result in the coupling
- This is evidenced by the strong dependence of the magnitude of the coupling on the angle, Φ , between the -C-H bond and the π orbital in the double bond
 - when the -C-H bond is perpendicular to the plane of the C=C bond, the π orbital is also perpendicular, the orbital overlap is maximized as is the coupling (${}^4J_{\text{HH}} \approx 3$ Hz)

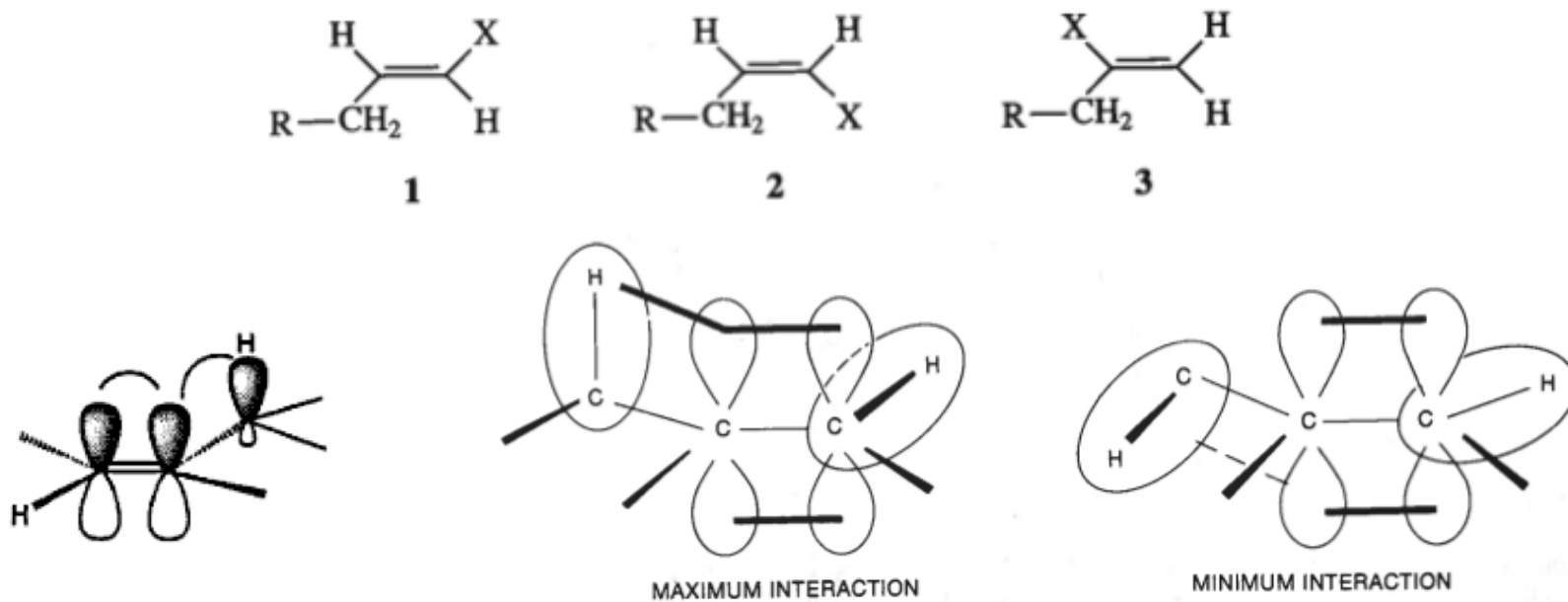

“LONG-RANGE” COUPLINGS: ALLYLIC COUPLINGS IN ALKENES

- Allylic couplings in alkenes: examples

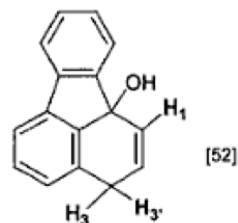

$$\phi_{13} = 155^\circ \quad \phi_{13'} = 85^\circ$$

$${}^4J_{13} = 0.8 \text{ Hz} \quad {}^4J_{13'} = 2.6 \text{ Hz}$$

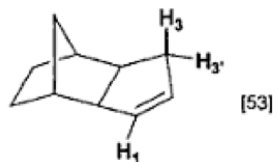

$$\phi_{13} = 120^\circ \quad \phi_{13'} = 120^\circ$$

$${}^4J_{13} = 2.0 \text{ Hz} \quad {}^4J_{13'} = 2.2 \text{ Hz}$$

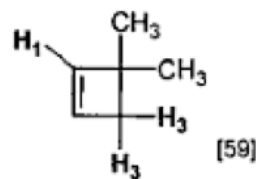

$${}^4J_{13} = 0.0 \text{ Hz}$$

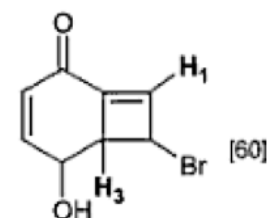

$${}^4J_{13} = 0.0 \text{ Hz}$$

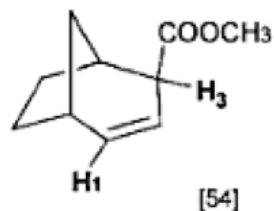

$$\phi_{13} = 125^\circ$$

$${}^4J_{13} = 2.3 \text{ Hz}$$

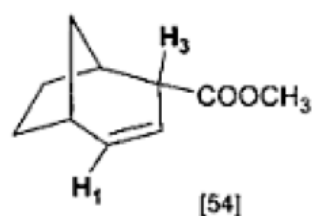

$$\phi_{13} = 115^\circ$$

$${}^4J_{13} = 2.6 \text{ Hz}$$

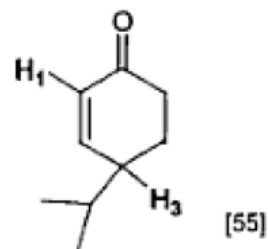

$$\phi_{13} = 100^\circ$$

$${}^4J_{13} = 1.3 \text{ Hz}$$

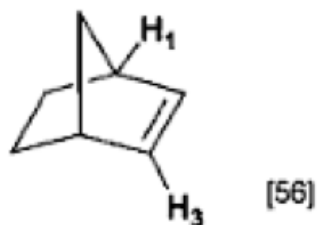

$${}^4J_{13} = 0.7 \text{ Hz}$$

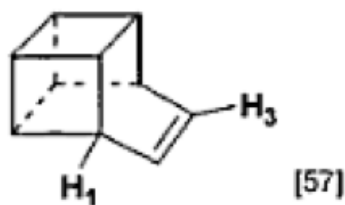

$${}^4J_{13} = 1.0 \text{ Hz}$$

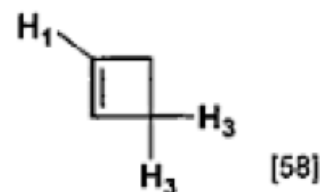

$${}^4J_{13} = -0.35 \text{ Hz}$$

"LONG-RANGE" COUPLINGS: AROMATIC (BENZENE) RINGS

- Long-range couplings are often observed in aromatic (benzene) ring systems
- Because the hydrogens lie in the plane of the ring, conformation does not play a significant role in determining the magnitudes of the couplings (they depend nearly entirely on the number of bonds separating the hydrogens)
- These can be useful for determining the arrangements of hydrogens and substituents on the ring
- Electronegativities of substituents can also influence the magnitudes of these couplings

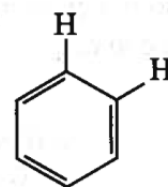

ortho
 $^3J = 7 - 10 \text{ Hz}$

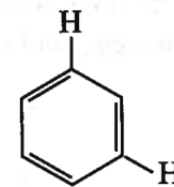

meta
 $^4J = 1 - 3 \text{ Hz}$

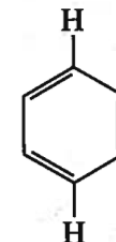

para
 $^5J = 0 - 1 \text{ Hz}$

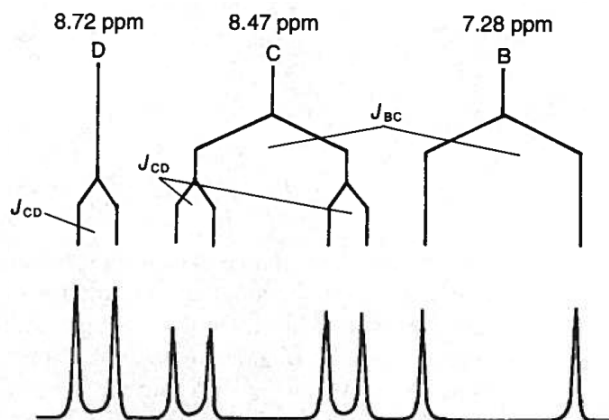
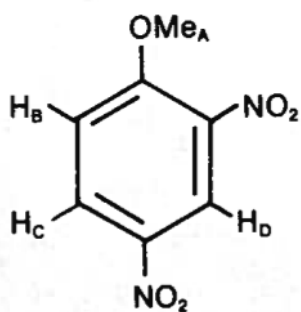

$^3J_{BC} \sim 8$ *ortho*
 $^4J_{CD} \sim 2$ *meta*
 $^5J_{BD} \sim 0$ *para*

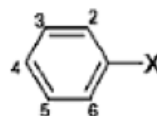

Coupling constants (Hz)

	$^4J_{24}$	$^4J_{35}$	$^5J_{25}$
X=H	1.37	1.37	0.66
CH ₃	1.54	1.29	0.60
COOCH ₃	1.35	1.31	0.63
Br	1.12	1.78	0.46
OCH ₃	1.03	1.76	0.44
N(CH ₃) ₂	1.01	1.76	0.43

“LONG-RANGE” COUPLINGS: $^X J_{HH}$, $X > 4$

- Five-bond or longer-range couplings are not common
- They can occur for “zig-zag” bond paths in unsaturated compounds
- Examples: naphthalene (**20**), benzaldehyde (**21**), allenes (**22**), alkynes (**23**), unsaturated five membered heterocycles (**24**)

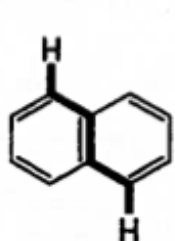

0.8 Hz
20

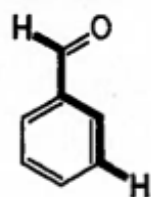

0.4 Hz
21

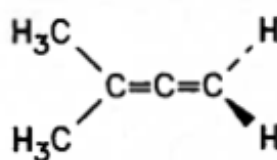

3.0 Hz
22

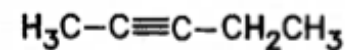

2.6 Hz
23



X = O, NH
up to 7.0 Hz
24

- Other examples:

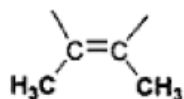

$^5 J = 1.2 - 1.8$ Hz

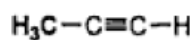

$^4 J = 2.9$ Hz



$^5 J = 2.7$ Hz

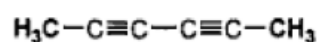

$^6 J = 1.3$ Hz

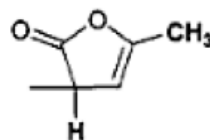

$^5 J = 2.7$ Hz

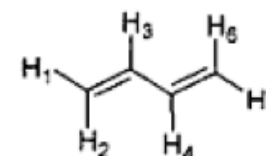

butadiene

$^2 J_{12} = 1.8$ Hz

$^3 J_{13} = 10.2$ Hz

$^4 J_{14} = 0.9$ Hz

$^5 J_{16} = 1.3$ Hz

$^3 J_{23} = 17.1$ Hz

$^3 J_{24} = 0.8$ Hz

$^5 J_{15} = 0.6$ Hz

$^3 J_{24} = 10.4$ Hz

$^5 J_{25} = 0.6$ Hz

COUPLING CONSTANTS AND STRUCTURE: GEMINAL

COUPLINGS

- Geminal ^1H - ^1H coupling constants ($^2J_{\text{HH}}$) are generally less useful for defining structure
- These depend in a complicated fashion on:
 - substituent effects
 - carbon atom hybridization
 - H-C-H bond angle
- Of course, no coupling is observed between equivalent geminal hydrogens
- Couplings are generally negative, and range from approximately -15 to 0 Hz
 - notable exceptions include formaldehyde ($\text{O}=\text{CH}_2$, + 41 Hz)

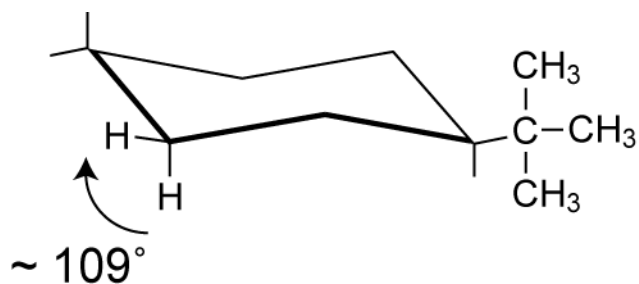

$$^2J_{\text{H,H}} \approx -12 \text{ to } -18 \text{ Hz}$$

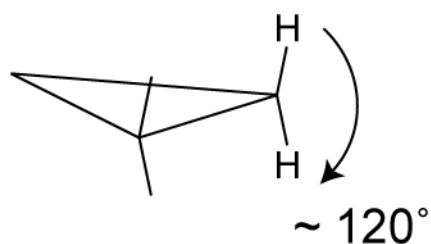

$$^2J_{\text{H,H}} \approx -5 \text{ Hz}$$

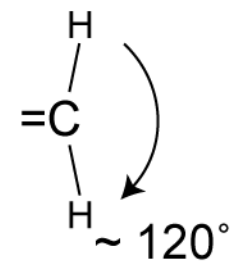

$$^2J_{\text{H,H}} \approx -3 \text{ to } +3 \text{ Hz}$$

C,H COUPLINGS

- One-bond C,H couplings ($^1J_{\text{CH}}$) are typically large, always positive, and depend roughly on the hybridization of the carbon

$$(^1J_{\text{CH}}) \approx 500 s$$

where 's' is the fraction of s character in the hybrid orbital (varies from 0.25 (sp^3) to 0.5 (sp))

	H ₃ C-CH ₃	H ₂ C=CH ₂	C ₆ H ₆	HC≡CH	Compound	$^1J(\text{C,H})$ [Hz]	Compound	$^1J(=\text{C,H})$ [Hz]
$^1J(\text{C,H})$ [Hz]	124.9	156.4	158.4	249.0	Cyclopropane	160.3	Cyclopropene	228.2
Hybridization	sp^3	sp^2	sp^2	sp	Cyclobutane	133.6	Cyclobutene	168.6
s-fraction	0.25	0.33	0.33	0.5	Cyclopentane	128.5	Cyclopentene	161.6
					Cyclohexane	125.1	Cyclohexene	158.4
					Cyclodecane	124.3	$\text{C}_n\text{H}_{2n-2}$ ($n > 6$)	≈ 156

- One-bond C,H couplings ($^1J_{\text{CH}}$) are affected significantly by substituents:

- electronegative substituents increase $^1J_{\text{CH}}$
- electropositive substituents decrease $^1J_{\text{CH}}$
- apparently, this is due to the inductive effect and not hybridization changes

$^{13}\text{CH}_3\text{-X}$	$^1J(\text{C,H})$ [Hz]
F	149.1
Cl	150.0
OH	141.0
H	125.0
CH ₃	124.9
Li	98.0

C,H COUPLINGS

- Two-bond C,H couplings (geminal, ${}^2J_{\text{CH}}$) are highly variable ranging mostly from about -10 to +20 Hz, with some notable exceptions (acetylene and derivatives)
- Three-bond C,H couplings (vicinal, ${}^3J_{\text{CH}}$) are related to the dihedral angle in a manner very similar to the relationship for ${}^3J_{\text{HH}}$ couplings
 - the largest couplings are for dihedral angles of $\sim 180^\circ$ and $\sim 0^\circ$ (${}^3J_{\text{CH}} 180^\circ > {}^3J_{\text{CH}} 0^\circ$)
 - the smallest couplings are for dihedral angles near 90°
 - ${}^3J_{\text{CH}}$ couplings also depend on CC bond length, bond angle and electronegativities of substituents
 - in ethylene derivatives (**26**), ${}^3J_{\text{CH}} \text{ trans} > {}^3J_{\text{CH}} \text{ cis}$ (like ${}^3J_{\text{HH}}$ couplings)
 - likewise, ${}^3J_{\text{CH}} \text{ trans}$ in (**28**) $>$, ${}^3J_{\text{CH}} \text{ cis}$ in (**27**)

Compound	${}^2J(\text{C,H})$ [Hz]
Ethane	- 4.5
Ethylene	- 2.4
Benzene	+ 1.1
Acetylene	+49.6

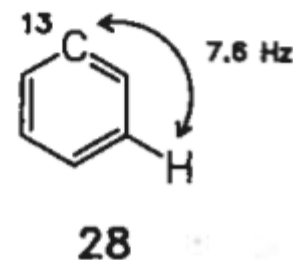
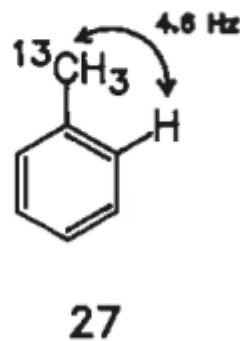
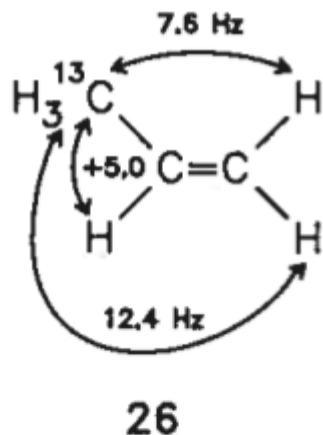

C,H COUPLINGS

- Long-range C,H couplings (${}^XJ_{\text{CH}}$, $X \geq 3$) large enough to be observed are uncommon, but in some conjugated π systems they sometimes are observed
- C,H couplings in benzene derivatives:
 - ${}^1J_{\text{CH}}$ are very large
 - ${}^2J_{\text{CH}}$ range from small positive (+1 Hz) to modest negative(-4 Hz) values
 - ${}^3J_{\text{CH}}$ are larger than ${}^2J_{\text{CH}}$, ranging from +6 to +12 Hz
 - ${}^4J_{\text{CH}}$ range from -1 to -2 Hz

X	${}^1J(\text{C}^1, \text{H}^1)$	${}^2J(\text{C}^1, \text{H}^2)$	${}^3J(\text{C}^1, \text{H}^3)$	${}^4J(\text{C}^1, \text{H}^4)$
	[Hz]			
H	158.4	+1.1	+ 7.6	-1.3
CH ₃		+0.5	+ 7.6	-1.4
Cl		-3.4	+10.9	-1.8
F		-4.9	+11.0	-1.7

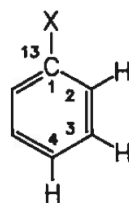

- Substituent effects are complicated

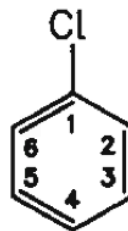

${}^1J(\text{C}, \text{H})$:	161.4 to 164.9 Hz
${}^2J(\text{C}, \text{H})$:	-3.4 to +1.6 Hz
${}^3J(\text{C}, \text{H})$:	5.0 to 11.1 Hz
${}^4J(\text{C}, \text{H})$:	-0.9 to -2.0 Hz

C,C COUPLINGS

- Not normally observed because of low ${}^{13}\text{C}$ natural abundance
- Are observed if ${}^{13}\text{C}$ -labeling is used to increase ${}^{13}\text{C}$ content
- Magnitudes range from 30 to 180 Hz
- Can be difficult to eliminate by decoupling, especially at high field strengths

Compound	${}^1J(\text{C}, \text{C})$ [Hz]
Ethane	34.6
Ethylene	67.6
Acetylene	171.5

ORDER OF A SPECTRUM

- The “weak coupling” or “first order” approximation assumes that, for simple coupled systems, the difference between the *Larmor frequencies* of the coupled nuclei is large compared to the coupling (constant) between them:

$$\Delta\nu \gg J$$

- The simple multiplicity rules we’ve defined so far for analyzing coupling, for instance, assume first order:

$$M = 2nI + 1$$

$$M = n + 1 \text{ (for spin } \frac{1}{2}\text{)}$$

M is the multiplicity (number of lines in the signal)

n is the number of equivalent coupled nuclei

I is the spin quantum number

- The analysis of higher order spectra is more complicated, as multiplicity is no longer governed by only simple rules
- The convention for coupled spin system nomenclature includes spectral order designation:
 - letters far apart in the alphabet (representing nuclei with large Larmor frequency differences, i.e. $\Delta\nu \gg J$) designate first order systems (AX, for instance)
 - letters close in the alphabet (representing nuclei with similar Larmor frequencies, i.e. $\Delta\nu \approx J$) designate higher order systems (AB, for instance)
- **Importantly**, as the static magnetic field strength (B_0) increases, spectra tend towards first order (J is field independent, and $\Delta\nu$ increases linearly with B_0) !

STRONG COUPLING: SECOND ORDER SPECTRA

- The “weak coupling” or “first order” approximation assumes that, for simple coupled systems, the difference between the *Larmor frequencies* of the coupled nuclei is large compared to the coupling (constant) between them:

$$\Delta\nu \gg J$$

- When $\Delta\nu$ approaches J , the coupling is called “strong” and the spectra are called “second-order” spectra
- The analysis of second-order spectra is more complicated, as multiplicity is no longer governed by only simple rules
- Example: $-\text{CH}_2-\text{CH}_2-$ group, ^1H spectrum at low B_0 field (low $\Delta\nu$)
 - the simple “triplet” signals (intensities 1:3:1) expected for hydrogens of an apparent A_2X_2 spin system (the $-\text{CH}_2-\text{CH}_2-$) group are not observed
 - the signals are complex and cannot be analyzed by the simple first order rules
 - the spectrum is therefore second order, and the spin system is A_2B_2

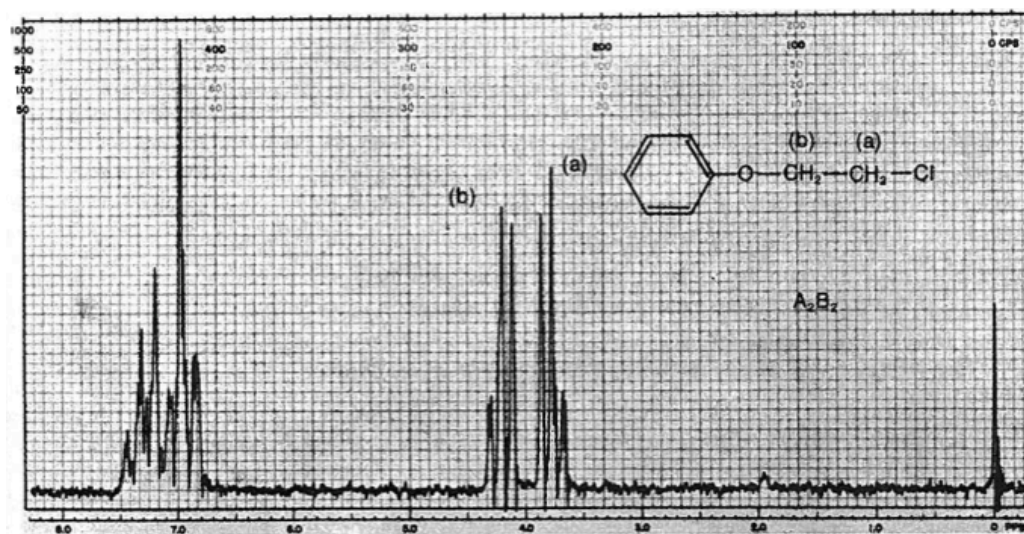

STRONG COUPLING: SECOND ORDER SPECTRA

- Two coupled hydrogens may constitute an AX, AB, or A₂ spin system, depending on the relative values of the coupling constant and the difference in their Larmor frequencies (J and $\Delta\nu$, respectively)
- For two adjacent (coupled) methine hydrogens, when $\Delta\nu/J$ is large, the spin system is AX, and the splitting pattern is a doublet for each hydrogen, with equal intensities (1:1) for each peak in the doublet and the chemical shift for each hydrogen is the center of its doublet
- If $\Delta\nu/J$ is smaller, the signals are no longer first order, as the outer peaks of the doublets get smaller and the inner peaks get larger, and the chemical shifts for the two hydrogens are no longer the centers of the doublets
- At the extreme, the two hydrogens are equivalent and the spin system is called A₂. No coupling (peak splitting) is observed between equivalent nuclei

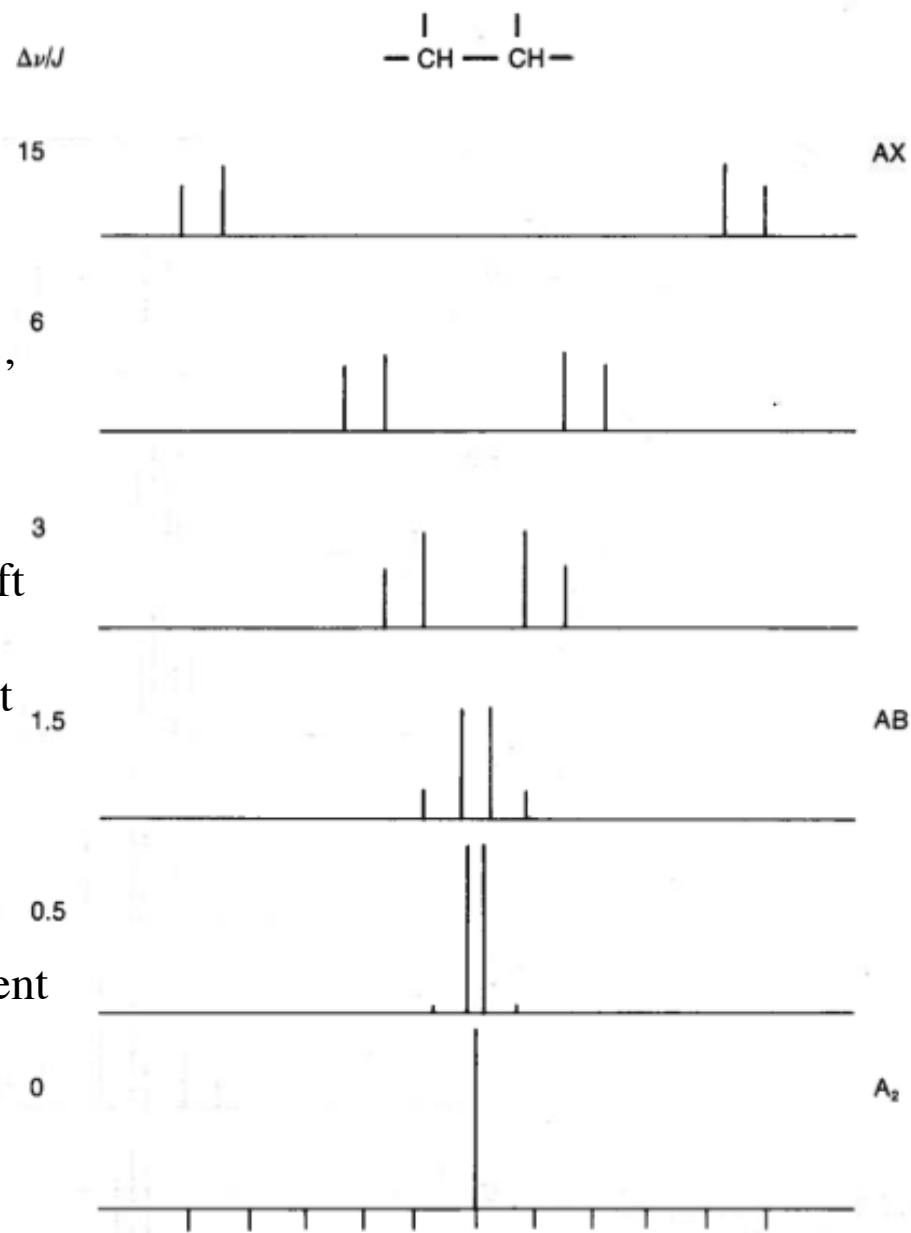

STRONG COUPLING: SECOND ORDER SPECTRA

- For a simple AX system, such as adjacent methine hydrogens:
 - the peaks in each doublet are of equal height
 - the chemical shifts for each hydrogen are the centers of the doublets
 - the coupling constant is the distance (Hz) between the two peaks of the doublet

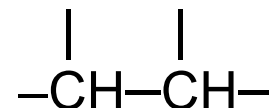

- For such a system where $\Delta\nu$ approaches J , and the system becomes AB:
 - the inner peaks of the doublets are more intense than the outer peaks (“roof effect”)
 - the chemical shifts of the hydrogens are closer to the inner peaks than the outer peak (they are not centered between the peaks of the doublet)
 - the coupling constant is still the distance (Hz) between the two peaks in the doublet

$$\delta_A - \delta_B = \sqrt{(\delta_1 - \delta_4)(\delta_2 - \delta_3)}$$

where $\delta_1, \delta_2, \delta_3, \delta_4$ are the chemical shifts of the individual peaks in the spectrum, as shown (right) and δ_A and δ_B are equidistant from the midpoint between the two signals

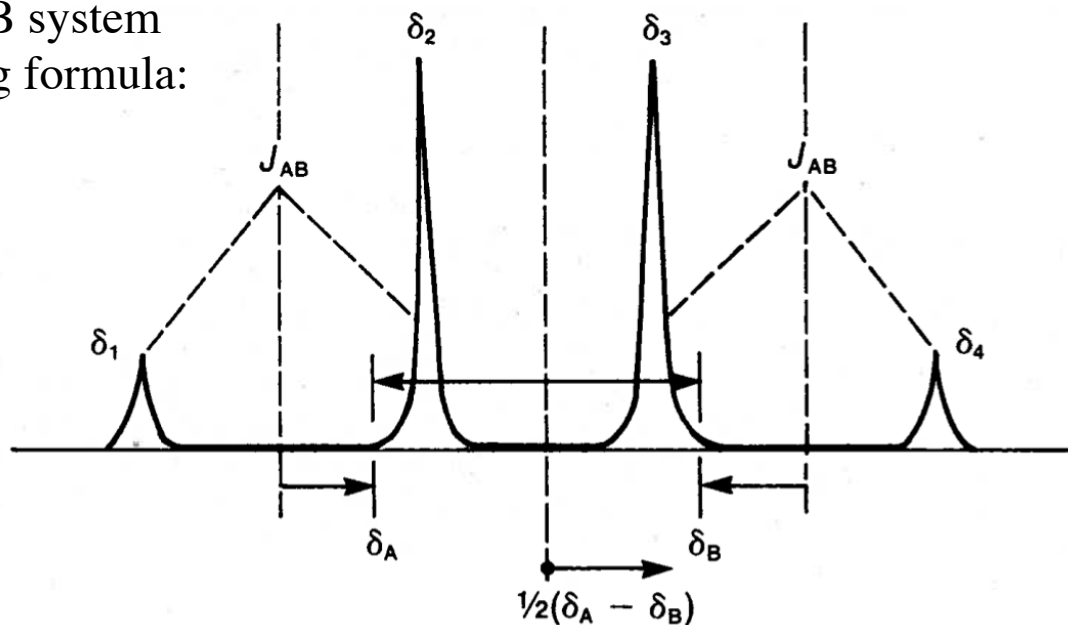

STRONG COUPLING: SECOND ORDER SPECTRA

- AX_2 / AB_2 and A_2X_2 / A_2B_2 spin systems: note the very complex behavior (appearance of additional peaks, etc.) as the spectra become second order

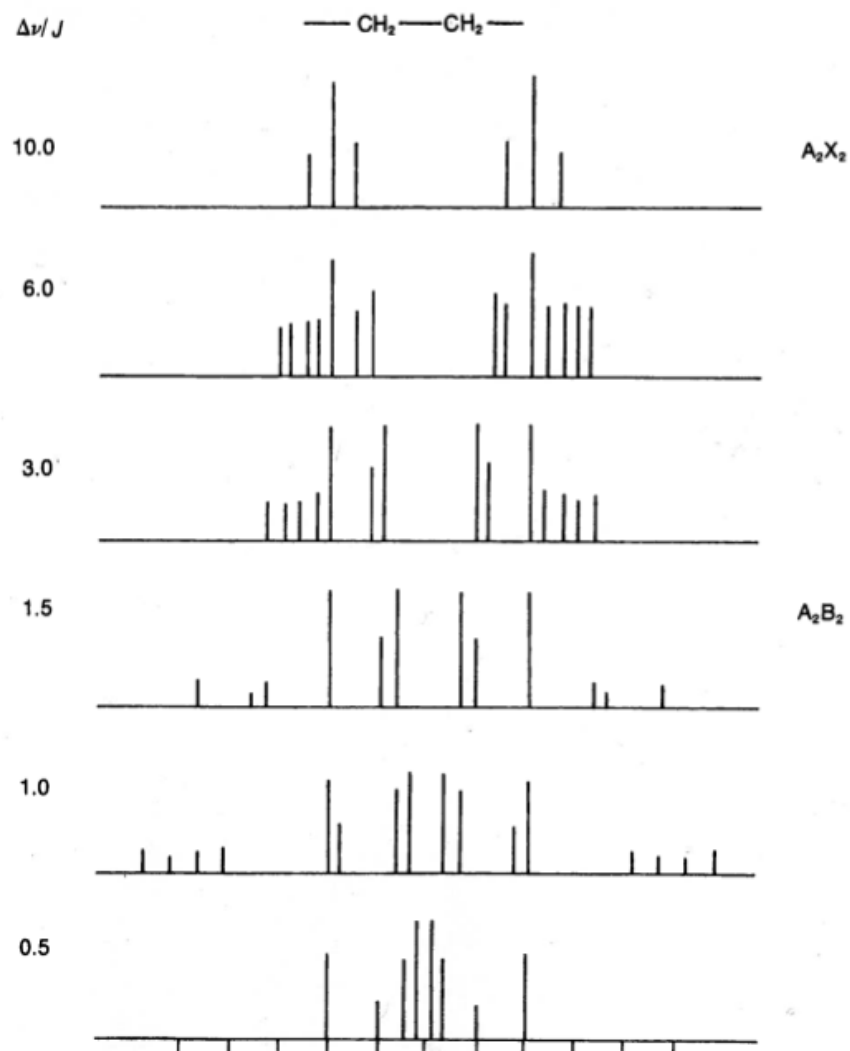
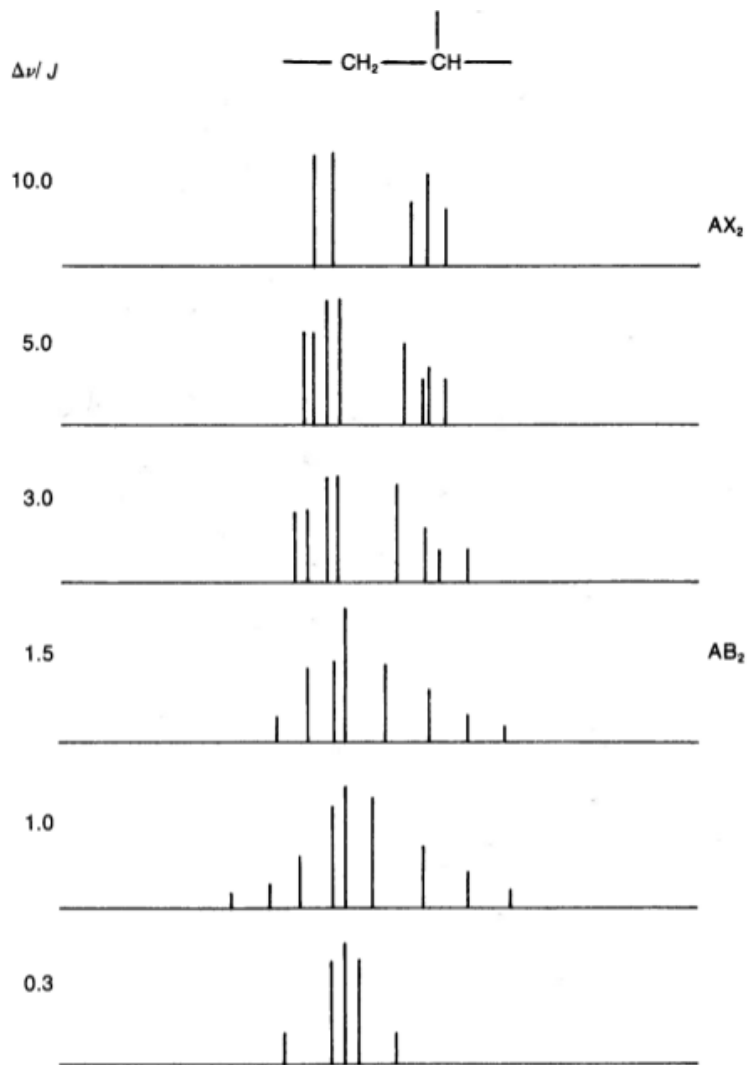

STRONG COUPLING: SECOND ORDER SPECTRA

- Final Examples: AB (again), and ABX

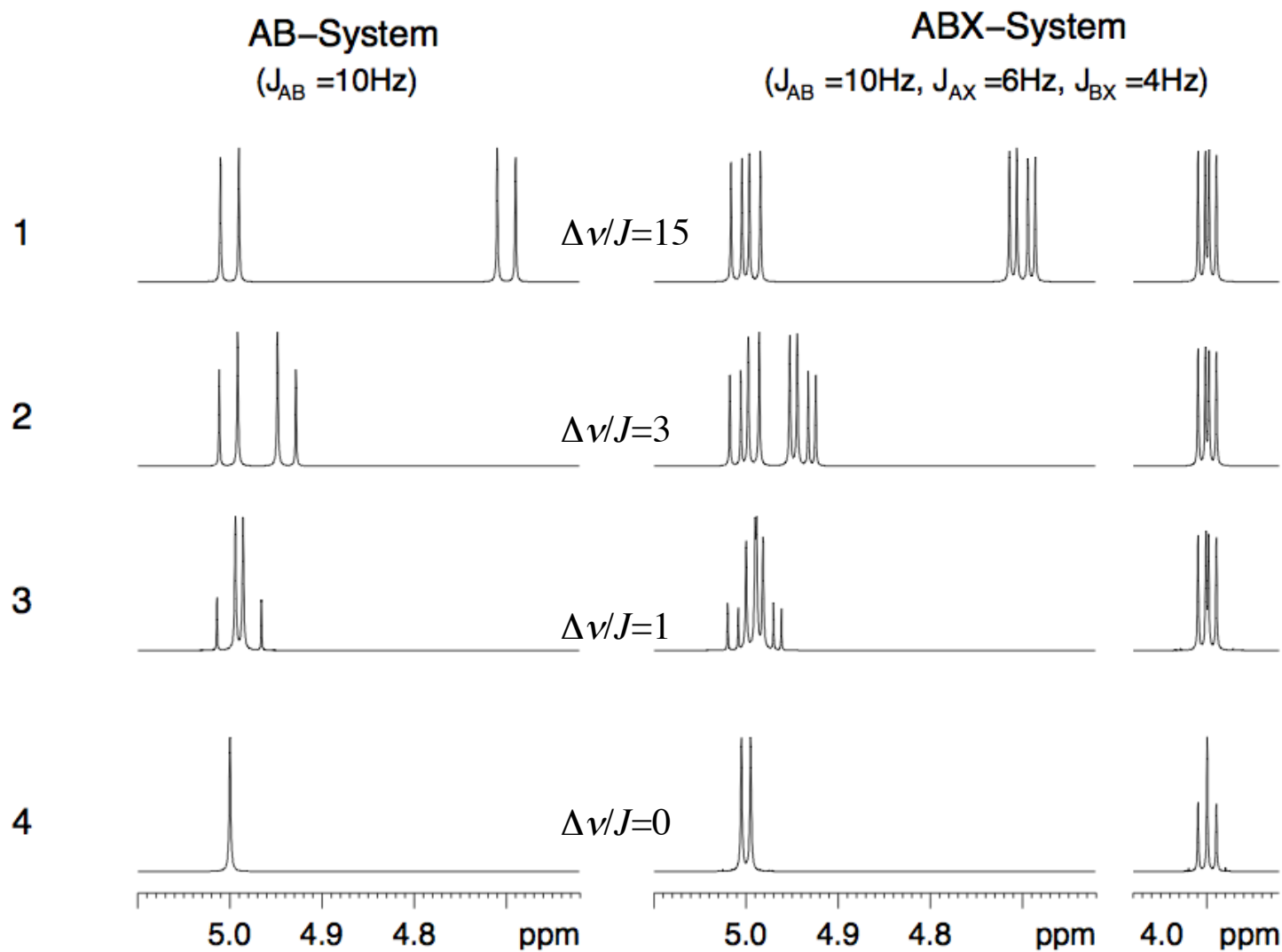

EQUIVALENCE AND STRUCTURE

- The term “equivalence” in NMR is used to define structural and magnetic properties of nuclei
- Nuclei are said to be *chemically equivalent* if:
 - the nuclei are the same isotopic species
 - they are exchanged by a molecular symmetry operation (including rotations/inversions), i.e. they have identical Larmor frequencies/chemical shifts (not by coincidence)
- Magnetic equivalence is a form of chemical equivalence
- Nuclei are said to be *magnetically equivalent* if:
 - they must have identical Larmor frequencies/chemical shifts (and not by coincidence or by chance)
 - they have *identical* couplings to *all* other spins in the molecule (or there are no other spins in the molecule)
 - a corollary is that no observable signal splitting results from coupling of magnetically equivalent nuclei
- In *first order spectra*, couplings between equivalent nuclei cannot be observed
 - for instance, all the hydrogens in benzene are chemically equivalent and give a single signal that is *not* split by couplings to one another, even though they are all coupled

CHEMICAL EQUIVALENCE AND STRUCTURE: EXAMPLES

- Homotopic nuclei: *chemically equivalent*

- homotopic hydrogens are those in identical environments
- they are related by a bond rotation or axis of rotation
- if two hydrogens are homotopic, the molecules resulting from substituting each by deuterium are identical
- *Larmor frequencies/chemical shifts are identical*

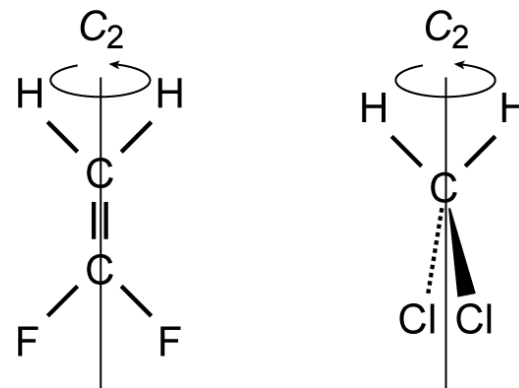

- Enantiotopic (prochiral) nuclei: *not* chemically equivalent

- enantiotopic hydrogens are in mirror image environments (enantiomeric molecules are non-superimposable mirror images of one another)
- if two hydrogens are enantiotopic, the molecules resulting from substituting each by deuterium are enantiomers
- enantiotopic hydrogens *appear* chemically equivalent, but they are not
- *however, their Larmor frequencies/chemical shifts are typically identical (isochronous) under normal conditions*
- they often do not have identical chemical shifts in chiral media

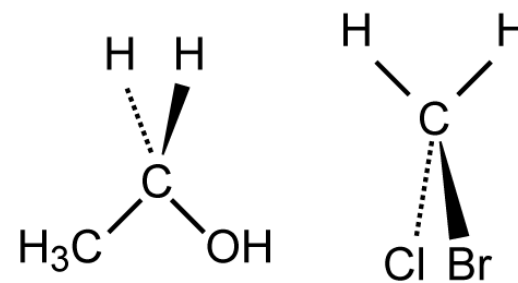

EQUIVALENCE BY RAPID INTERNAL MOBILITY

- In ethyl chloride, there is a clear plane of symmetry
- If we consider the leftmost conformation shown below (in the Newman projection), we conclude:
 - the methylene hydrogens are *not* equivalent (are enantiotopic), but they have the same chemical shift (isochronous) in achiral media
 - if we consider only this conformation, H₁ and H₂ of the methyl group are enantiotopic
 - H₃ cannot be exchanged with the others by a symmetry operation, therefore it is apparently not equivalent with any of the others
- *However*, the methyl group rotates rapidly about the C-C bond, AND if we examine the three conformers below, we see that they are isoenergetic. Thus:
 - the average chemical environments of each of the methyl hydrogens are identical
 - *therefore, the methyl hydrogens are equivalent and have identical chemical shifts*

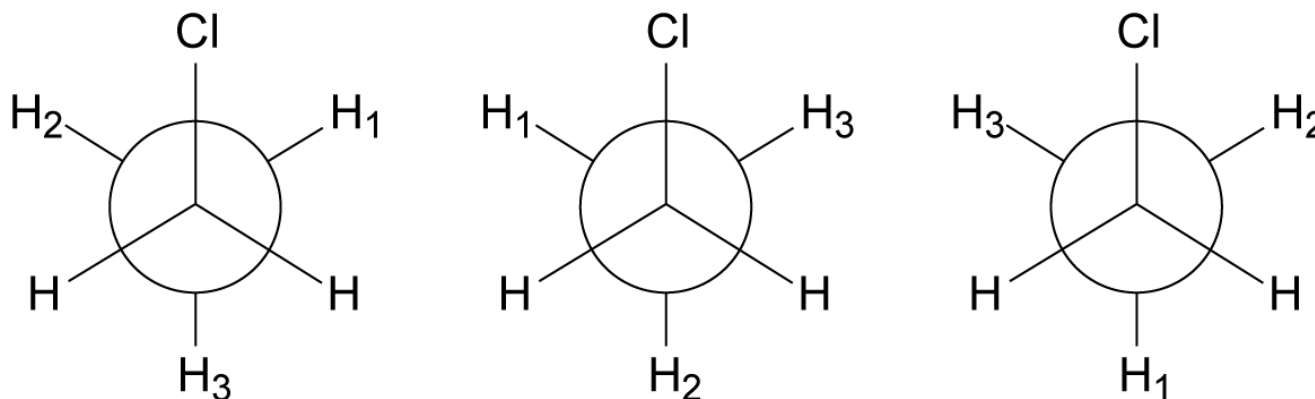
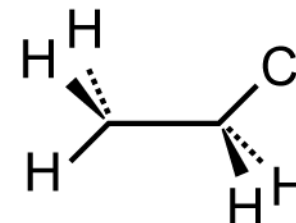

CHEMICAL EQUIVALENCE AND STRUCTURE: EXAMPLES

- Diastereotopic nuclei: *not* chemically equivalent, and do *not* have identical chemical shifts
 - Larmor frequencies/chemical shifts of diastereotopic hydrogens are *not* identical (except, perhaps, by chance)
 - diastereomeric hydrogens are in different chemical environments and are not related by symmetry or bond rotations
 - diastereomers are stereoisomers that are not enantiomers
 - chiral center next to methylene guarantees the methylene hydrogens are diastereotopic

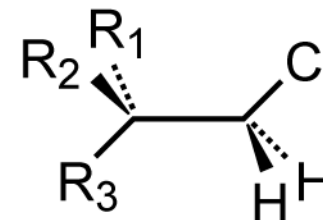

- Consider this molecule and its Newman projections:

- no planes of symmetry, so the two methylene hydrogens are not equivalent
- no two conformations are isoenergetic (at thermal equilibrium, the concentrations of each are different)

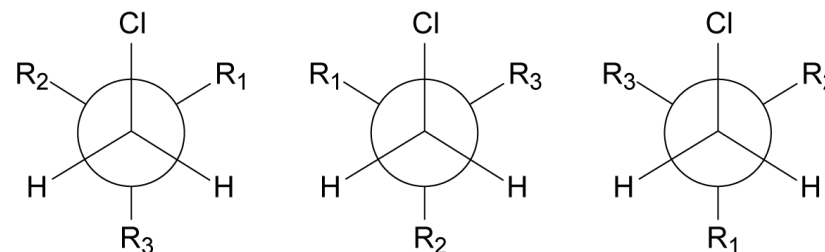

- rapid rotation about the central C-C bond will not “average” the environments
- *the two hydrogens shown will have different chemical shifts*

MAGNETIC EQUIVALENCE AND STRUCTURE: EXAMPLES

- Magnetic equivalence requires that the chemical shifts be identical and the couplings to all other spins in the molecule are also identical
- In each of the molecules shown below, the hydrogens are chemically equivalent (clear planes of symmetry)
- In each of the molecules, the coupling constants between each hydrogen and a given carbon atom are identical (the coupling constants between each fluorine and a given carbon atom are also identical)
- However, in the molecule on the left, ${}^3J_{H_a, F_b}$ (a *trans* arrangement) is clearly different than ${}^3J_{H_b, F_b}$ (a *cis* arrangement)
- In the molecule on the right the spatial relationships between each hydrogen and each fluorine are identical, thus, the hydrogens are magnetically equivalent (the fluorines are also magnetically equivalent)

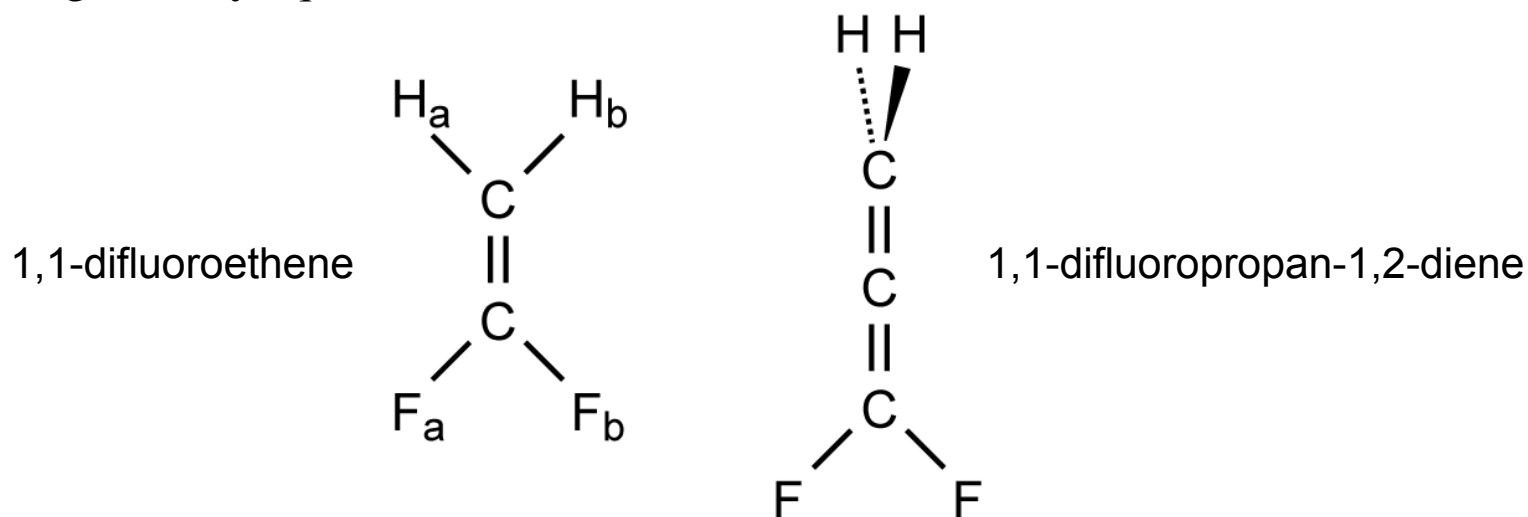

EQUIVALENCE AND STRUCTURE: OTHER EXAMPLES

benzene: C_6 symmetry, all ^1H chemical shifts identical (same for ^{13}C)

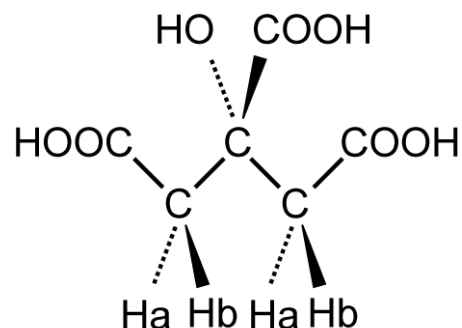
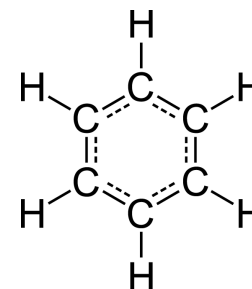

citric acid: is a plane of symmetry, but hydrogens within in a given methylene group are diastereotopic (two sets of equivalent hydrogens, in different methylene groups)

(S)-(+)-3-methyl-2-butanol

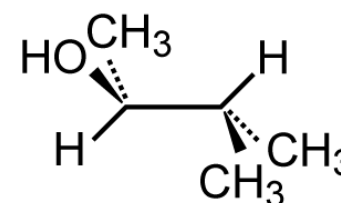

the methyl groups on carbon 3 of 3-methyl-2-butanol are diastereotopic (each gives a distinct signal in ^1H and ^{13}C spectra)

